

All sitting heights measured without load - a variation may occur depending on the load due to contraction of gas-struts, springs, upholstery and third part equipment. All information herein contained is subject to change without notice unless under contractual configuration control. Please consult NorSap if dimensions are critical or a certified drawing is required.

www.norsap.no

Chair interface:

M10 THRU ALL

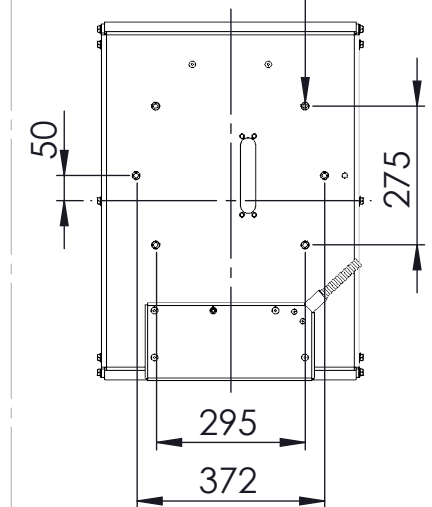

Weight: 0.00



Mjåvannsvegen 45/47
NO 4626 Kristiansand (Norway)

Description:

**STANDARD DECK RAIL
FLUSH MOUNTED**

Art.-No.:
6351-2000

Date:
16.01.2020

Revision: