

All sitting heights measured without load - a variation may occur depending on the load due to contraction of gas-struts, springs, upholstery and third part equipment. All information herein contained is subject to change without notice unless under contractual configuration control. Please consult NorSap if dimensions are critical or a certified drawing is required.

www.norsap.no

Chair interface:

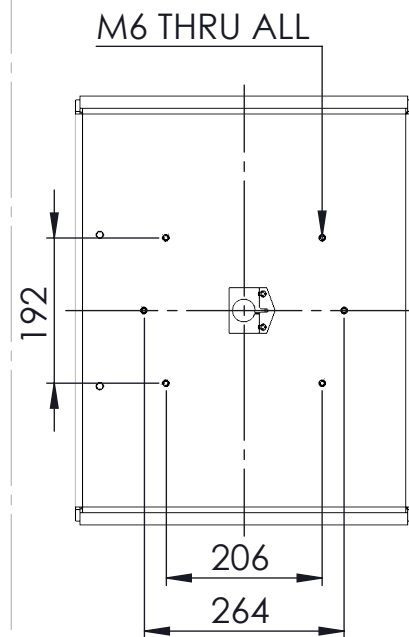

Weight: 4991.93



Mjåvannsvegen 45/47
NO 4626 Kristiansand (Norway)

Description:

BASIC DECK RAIL FLUSH MOUNTED

Art.-No.:
6653-3000

Date:
14.01.2020

Revision: