

All sitting heights measured without load - a variation may occur depending on the load due to contraction of gas-struts, springs, upholstery and third part equipment. All information herein contained is subject to change without notice unless under contractual configuration control. Please consult Norsap if dimensions are critical or a certified drawing is required.

www.norsap.no

Chair interface:

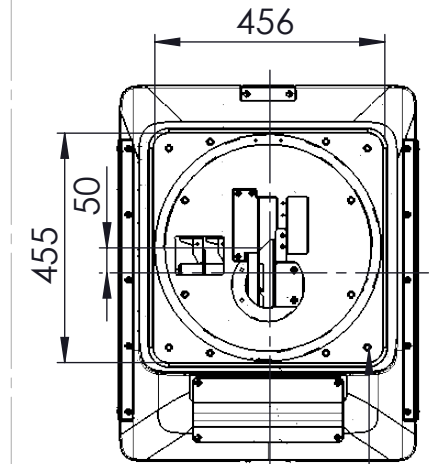

Ø 9 THRU ALL
M10 - 6H THRU ALL

Weight: 0.00



Mjåvannsvegen 45/47
NO 4626 Kristiansand (Norway)

Description:

ACTIVE DECK RAIL TOP MOUNTED

Art.-No.:
6694-2000

Date:
15.03.2022

Revision: